

# BIKE.CASES & BAGS





Auf zwei Rädern in einer neuen Umgebung Grenzerfahrungen zu sammeln oder während der kalten Monate in warmen Gefilden einige Trainingseinheiten zu absolvieren – es gibt viele Gründe für das Reisen mit dem eigenen Rad.

bike.cases & bags von B&W schützen Ihr Rad während des Transports und des Fluges. Wer jemals gesehen hat, wie Koffer beim Be- und Entladen von Flugzeugen behandelt werden, der weiß, welchen Belastungen sie dabei ausgesetzt sind.

Mit stabilen Schengeometrien, robusten Materialien, verstärkten Leichtlaufrollen sowie integrierten Spanngurten sind unsere bike.cases speziell für diese Anforderungen konzipiert und sorgen für Sicherheit und Stabilität.

# TRAVEL COMPANION

**B&W** BIKE.CASES & BAGS

There are many reasons to take your own bike when you travel, whether it is for winter training in warm climates or just a fun cycling tour holiday. It is essential your bike gets there in perfect condition. This is one thing you can rely on thanks to the clever innovations developed and produced by B&W covering safe transport by road, rail and air. If you have ever seen cases and bags loaded and unloaded by airline baggage handlers, you will know how easily they can be mistreated.

Our bike cases and bags have strong shells made from durable materials, high density fabrics, reinforced smooth-running wheels, integrated tension belts and robust padding, as well as many other features to guarantee that your bicycle will be safe and secure during transport.

# SEASON 2021/2022

4 find your perfect case  
bike travel cases

10 bike.case II



18 bike.bag II



22 Air travel information

26 foldon.family



33 tool.cases

6 bike.guard curv



14 bike.box II



20 Accessories

24 B3 Bag



32 outdoor.cases

34 contacts

# FIND YOUR PERFECT CASE



bike.guard curv®

bike.case 2.0

bike.box 2.0

bike.bag 2.0

## RENN- & TRIATHLON RÄDER | ROAD and TRI-BIKES

**bis Rahmengröße 62 cm\***  
up to frame size 62 cm\*



**Rahmengröße >62 cm\***  
frame size >62 cm\*



**mit integrierter Sattelstütze\***  
with integrated seat post\*



## MOUNTAINBIKES

**Hardtail**



bis Rahmengröße 46 cm  
up to frame size 46 cm



**Fullsuspension**



**Downhill Bike**



## TREKKING BIKES



page

6

10

14

18

Länge x Höhe x Tiefe length x height x depth	bike.guard curv®	bike.case 2.0	bike.box 2.0	bike.bag 2.0
<b>Außenmaße (mm)</b> external dimensions (inch)	1.310 x 910 x 315 51.6 x 35.8 x 12.4	1.345 x 880 x 350 53.0 x 34.6 x 13.8	1.190 x 890 x 295 46.9 x 35.0 x 11.6	1.360 x 854 x 297 53.5 x 33.6 x 11.7
<b>Innenmaße (mm)</b> internal dimensions (inch)	1.300/1.070 x 840 x 285 51,2/42.1 x 33.1 x 11.8	1.300 x 815 x 320 51.2 x 32.1 x 12.6	1.150/825 x 810 x 280 45.3/32.5 x 31.9 x 11.0	1.350 x 810 x 280 53.2 x 31.9 x 11.0
<b>Verpackungsmaße (mm)</b> packing dimensions (inch)	1.340 x 930 x 210 52.8 x 36.6 x 8.3	1.355 x 860 x 335 53.3 x 33.9 x 13.2	1.200 x 920 x 200 47.2 x 36.2 x 7.9	1390 x 315 x 365 54.7 x 12.4 x 14.4
<b>Gewicht (inkl. Zubehör)</b> weight (incl. accessories)	10,9 kg / 24.0 lb	16,0 kg / 35.3 lb	11,7 kg / 25.8 lb	8,6 kg / 19 lb
<b>max. Zuladung</b> max. load	15 kg / 33.1 lb	20 kg / 44.1 lb	15 kg / 33.1 lb	15 kg / 33.1 lb
page	6	10	14	18

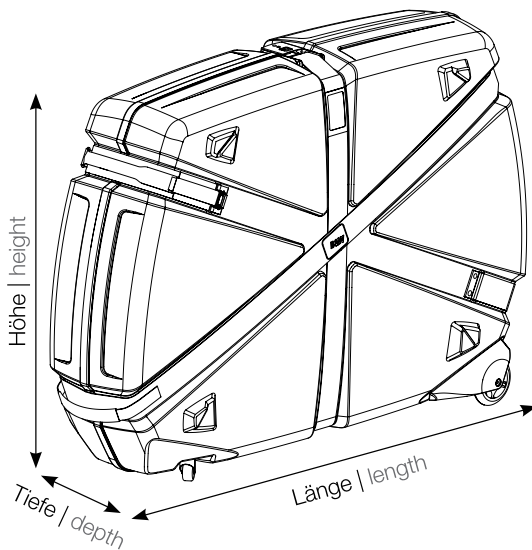

Hinweis: Die Maßangaben verstehen sich Länge x Höhe x Tiefe eines geschlossenen, aufrecht stehenden Koffers bzw. einer geschlossenen, aufrecht stehenden Tasche. Diese Tabelle dient nur einer ersten Orientierung. Für die tatsächliche Nutzungsmöglichkeit vergleichen Sie bitte die Innenmaße mit den Abmessungen des zerlegten Rades von der Vorderkante des Gabel-Ausfallendes bis zum Ende des Schaltwerks und die Höhe des Sattelrohres bis zur Unterkante des Kettenblattes. Ggf. muss das Schaltwerk demontiert werden. Messen Sie daher Vorderkante Gabel-Ausfallende bis Hinterkante Rahmen-Ausfallende. Für genauere Informationen ob Ihr Fahrrad in den Koffer passt nutzen Sie bitte den Konfigurator auf unserer Website unter: <https://www.b-w-international.com/de/fahrrad/>

**Beachten Sie bitte, dass das bike.bag 2.0 Ihrem Fahrrad, im Gegensatz zum bike.guard curv®, zur bike.box 2.0 und dem bike.case 2.0, nur im unteren Bereich guten Schutz bietet. Der obere Bereich bleibt weiter empfindlich gegen Druck- und Stoßbelastungen.**

Note: The dimensions stated are length x height x depth for a closed upright case or closed upright bag. This table only serves the purpose of providing initial orientation. For the actual possibilities of use, please compare the interior dimensions with the dimensions of the dismantled bike from the front edge of the fork drop to the end of the rear derailleur and the height of the seat post to the underside of the chain wheel. If necessary, the rear derailleur must be dismantled. Therefore you should measure the front edge of the fork drop to the back edge of the frame dro p. If you want to know in more detail if your bike fits, make use of our configurator on our website: <https://www.b-w-international.com/de/fahrrad/>

**Please note that the bike.bag 2.0 only offers protection in the lower section in contrast to the bike.guard curv®, the bike.box 2.0 and the bike.case 2.0. The top section remains fragile to pressure and impacts.**

# 96015 BIKE.GUARD CURV<sup>©</sup>

**Innenmaße** 1.300 (unten)/1.070 (oben) x 840 x 285 mm

**Außenmaße** 1.310 x 910 x 315 mm

**Gewicht** 10,9 kg

**Farbe** schwarz

**Material** eigenverstärktes PP (Curv<sup>©</sup>)

**internal dimensions** 51.2 (bottom)/42.1(top) x 33.1 x 11.8 inch

**external dimensions** 51.6 x 35.8 x 12.4 inch

**weight** 24.0 lb

**color** black

**material** self reinforced PP (Curv<sup>©</sup>)

**VIDEO TUTORIAL**  
on YouTube:





**Richard Murray**  
South African Triathlete

“Ich bin in einem Jahr 55 Mal mit meinem bike.guard curv geflogen. Mein Rad hat jeden Flug ohne Schäden überstanden. Keine gebogenen Räder, keine Kratzer, gar nichts. Die Laufräder blieben gut fixiert und die Gurte im Inneren hielten alles perfekt zusammen. Für mich gibt es keinen besseren Fahrradkoffer: Er ist superleicht, extrem robust und hat eine unglaubliche Lebensdauer.”



“I did 55 flights with my bike.guard curv in 1 year. It went to the US, New Zealand, Australia, Canada, Japan, Bahamas, Spain, Germany, Netherlands, Hawaii and a few more with no major damage. The wheels stayed on and the straps held everything perfectly together. My bike never got any damage at all, no bent wheels, no scratches, nothing at all. For me there is no better bike travel case out there: it is super light, it is strong and has an incredible life span.”



aus eigenverstärktem  
Curv® Material  
made of self-reinforced  
Curv® material

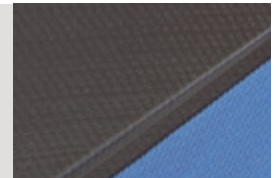

vier stabile Leichtlaufrollen,  
zwei 360° frei drehbar, zwei fest  
four stable and smooth-running  
wheels, two freely 360° rotatable,  
two fixed



leichtes Packen durch die  
abnehmbare Deckelschale  
for simplified packing, the top  
shell can be removed completely



selbstspannendes Gurtsystem  
self-tightening buckle



abschließbar mit TSA Schloss  
(nicht im Lieferumfang enthalten)  
lockable with a TSA padlock (not  
included)



# B&W

BIKE.CASES  
MERIDA TEAM





Flugreisen zu internationalen Rennen oder Trainingslagern können sich unsere zwölf Fahrer nicht mehr ohne die Taschen und Koffer von B&W vorstellen. „Früher haben wir unsere Bikes in Pappkartons gepackt und gehofft, dass sie heil am Zielort ankommen“, schmunzelt Simon Gutmann.

Das ist aber Geschichte. Seit 2015 ist das Team mit den funktionellen Koffern und Taschen von B&W unterwegs. Sei es der bike.sack, das bike.case 2.0, die bike.box 2.0, die Laufradtaschen, die B3 Bags oder das tool.case – unsere Bikes und unser Zubehör ist perfekt geschützt und wir müssen uns keine Sorgen mehr machen, ob wir am Zielort einsatzbereit sind.

Die Unterzeichnung 2019 mit B&W als Hauptsponsor, Namensgeber und großartigem Partner auf vielen Gebieten der Unterstützung macht uns als Team sehr stolz und wir freuen uns schon sehr auf weitere erfolgreiche, gemeinsame Jahre.

Air travel to international races or training camps is something our twelve riders can no longer imagine doing without B&W bags and cases. "In the past, we packed our bikes in cardboard boxes and hoped they would arrive at their destination in one piece," smiles

Simon Gutmann.

But that's history. Since 2015, the team has been traveling with B&W's functional cases and bags. Be it the bike.sack, the bike.case 2.0, the bike.box 2.0, the wheel bags, the B3 Bags or the tool.case - our bikes and accessories are perfectly protected and we no longer have to worry about whether we will be ready for action at our destination.

The signing in 2019 with B&W as main sponsor, name giver and great partner in many areas of support makes us very proud as a team and we are already very much looking forward to more successful years together.

**Andrea Gutmann**

Team Manager  
B&W bike.case Merida Team



# 96600 BIKE.CASE 2.0

**Innenmaße** 1.300 x 815 x 320 mm

**Außenmaße** 1.345 x 880 x 350 mm

**Gewicht** 16,0 kg

**Farbe** schwarz

**Material** ABS

**internal dimensions** 51.2 x 32.1 x 12.6 inch

**external dimensions** 53.0 x 34.6 x 13.8 inch

**weight** 35.3 lb

**color** black

**material** ABS



**VIDEO TUTORIAL**  
on YouTube:





umlaufender Aluminiumrahmen mit Stoßkantenschutz  
surrounding aluminum frame and impact protection



leichtes Packen durch die abnehmbare Deckelschale  
for simplified packing, the top shell can be removed completely



Trage- und Ziehgriffe für komfortables Handling  
carrying handles and pull handles for easy handling



vier stabile Leichtlaufrollen, zwei 360° frei drehbar, zwei fest  
four stable and smooth-running wheels, two freely 360° rotatable, two fixed



verstärkte Bodenschale im Bereich der vorderen Rollen  
reinforced bottom tray in the area of the front wheels



### Simon Gutmann

(Participant in Eliminator World Cups, European and World Championships):

“Das bike.case II ist bei Flugreisen ein unersetzlicher Begleiter. Er ist groß genug, um nicht nur das Mountainbike, sondern auch zusätzlich Laufräder unterzubringen. Und er ist super praktisch, sodass man bei seinen Touren zu Wettkämpfen im Ausland, wie beispielsweise der Sprint-WM in China, auch persönliche Dinge verstauen kann.”

“The bike.case II is an irreplaceable companion for air travel. It is large enough to accommodate not only the mountain bike, but also additional wheels. And it's super practical, since you can stow personal belongings to competitions abroad, such as the Sprint World Championships in China.”

# NATIONAL TEAM ISRAEL



Gerade im Profisport ist das Equipment unverzichtbar und benötigt den besten Schutz während des Transports. Viele international erfolgreiche Teams, wie auch das Nationalteam Israel sind von der Qualität der B&W bike.cases & bags überzeugt: "Als ehemaliger TT-Nationalmeister benutze ich die Koffer und Taschen von B&W. Das gibt mir die Gewissheit, dass mein Fahrrad während des Transports sicher und geschützt ist."



Especially in professional sports the equipment is indispensable and needs the best protection during transport.

Many successful international teams as well as the national team Israel are convinced of the quality of B&W bike.cases & bags: "As a former TT national champion, I use B&W cases and bags. That gives me peace of mind by knowing that my bike is safe and secure during transport."



### **Noa Borochovit**

Former TT national  
champion Israel

# 96500 BIKE.BOX 2.0

**Innenmaße** 1.150 (unten)/825 (oben) x 810 x 280 mm

**Außenmaße** 1.190 x 890 x 295 mm

**Gewicht** 11,7 kg

**Farbe** schwarz

**Material** ABS

**internal dimensions** 45.3 (bottom)/32.5(top) x 31.9 x 11.0 inch

**external dimensions** 46.9 x 35.0 x 11.6 inch

**weight** 25.8 lb

**color** black

**material** ABS



**VIDEO TUTORIAL**  
on YouTube:



**Fabian Wegmann**

racing bike professional, race director,  
television commentator



sieben zusätzliche Verstärkungen  
in Boden- und Deckelschale  
seven additional reinforcements in  
the bottom and lid tray



vier stabile Leichtlaufrollen,  
zwei 360° frei drehbar, zwei fest  
four stable and smooth-running  
wheels, two freely 360° rotatable, two  
fixed



leichtes Packen durch die  
abnehmbare Deckelschale  
for simplified packing, the top  
shell can be removed completely



selbstspannendes Gurtsystem  
self-tightening buckle



abschließbar mit TSA Schloss  
(nicht im Lieferumfang enthalten)  
lockable with a TSA padlock (not inclu-  
ded)



# TEAM NOVO NORDISK





"B&W bietet zuverlässige und funktionelle Produkte, die qualitativ hochwertig und praktisch in der Anwendung sind und unseren Fahrrädern ein hohes Maß an Schutz bieten. Mit den Fahrradtaschen von B&W können wir unbesorgt durch die Welt reisen, denn wir wissen, dass unsere Fahrräder geschützt und immer sicher sind."

"B&W offers reliable and functional products that are high quality, practical to use and provide great protection level for our bikes. B&W bike bags allow us to travel the world with peace of mind, knowing that our bikes are protected and always safe."

**Sergey Davidenko**

VP of Operations and Sponsorships

**team  
novo  
nordisk  
PRO CYCLING**

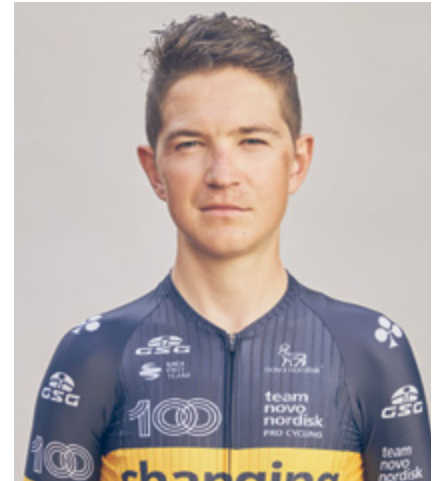

"Egal, ob ich mit meinem Fahrrad auf einem Langstreckenflug bin, zu einem Rennen fahre oder auf einem Kurztrip - mein B&W bike.bag 2.0 Koffer macht das Reisen mit meinem Fahrrad einfach. Er bietet großartigen Schutz, ist mit seinem 4-Rad-System leicht zu bewegen und garantiert, dass mein Fahrrad jedes Mal sicher ankommt. Ich glaube, es gibt nicht viel mehr, was man sich von einem Fahrradkoffer wünschen könnte."

"Whether it is travelling with my bike on a long haul flight, to and from races or a quick overnight trip, my B&W bike.bag 2.0 case makes travelling with my bike simple. It offers great protection, is easy to move with it's 4 wheel system, and always guarantees that my bike arrives safely every time. I don't think there is much more you could want from a bicycle case."

**Sam Munday**

Australian Pro Rider  
Team Novo Nordisk

Das Team Novo Nordisk ist das erste reine Diabetes-Radteam der Welt. Alle Athleten treten mit Typ-1-Diabetes an. Ziel ist es alle von Diabetes Betroffenen zu inspirieren, aufzuklären und zu stärken, während die Athleten gegen die besten Radfahrer der Welt antreten.

Team Novo Nordisk is the first pure diabetes cycling team in the world. All athletes compete with type 1 diabetes. The goal is to inspire, educate and empower everyone affected by diabetes as the athletes compete against the best cyclists in the world.

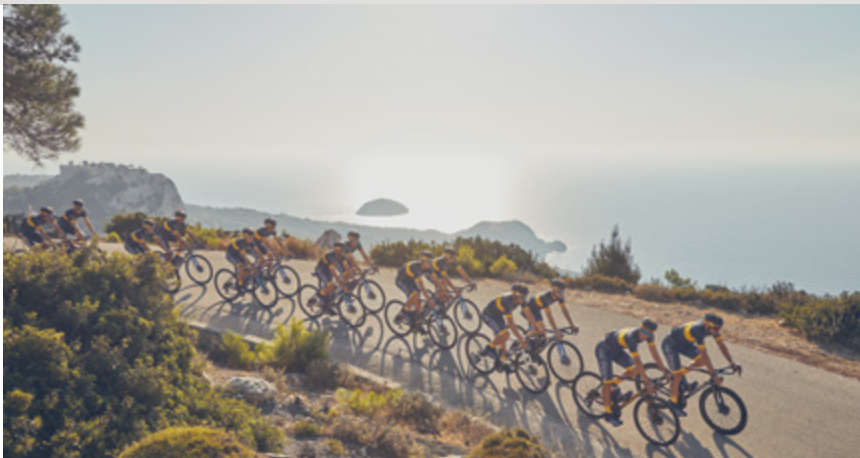

# 96900 BIKE.BAG 2.0

**Innenmaße** 1.350 x 810 x 280 mm

**Außenmaße** 1.360 x 854 x 297 mm

**Gewicht** 8,6 kg

**Farbe** grau/schwarz

**Material** ABS + Ripstop-Polyester

**internal dimensions** 53.2 x 31.9 x 11.0 inch

**external dimensions** 53.5 x 33.6 x 11.7 inch

**weight** 19 lb

**color** grey/black

**material** ABS + ripstop polyester



**VIDEO TUTORIAL**  
on YouTube:

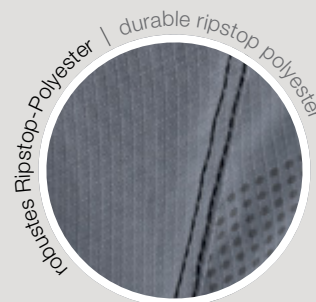
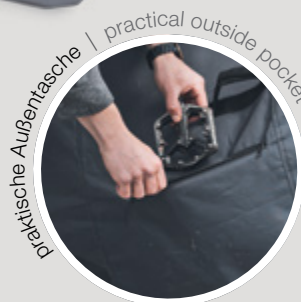
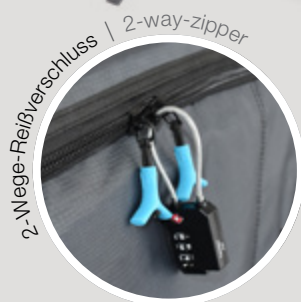



Integrierte Service-Matte  
für das Rad

Integrated service mat  
for the bike assembly work



Gepolsterter, anpassbarer Gabelschutz

Padded, adjustable fork protector

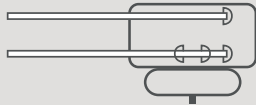

Sichere Fixierung auf dem  
verstellbaren Pedestal

Secure fixation on the adjustable  
pedestal

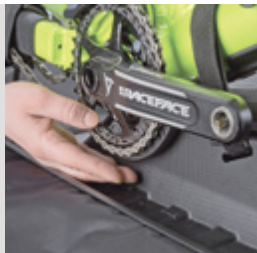

Innovatives Gurtsystem zur  
Fixierung des Rahmens

Innovative belt system for fixing  
the frame



Rundum-Schutz dank integrierter  
Polsterung

All round protection due to integrated  
soft padding



**DUNCAN SHAW**

**Duncan Shaw**

Street trials professional:

„Die Produktpalette von B&W International deckt alle Bedürfnisse eines reisenden Street-Trial-Fahrers ab. Wer qualitativ hochwertige Koffer und Transporttaschen sucht, die Equipment zuverlässig und einfach transportieren, ist bei B&W an der richtigen Adresse. Ich kann die cases und bags jedem Kollegen weiterempfehlen.“

„B&W International's product range covers all the needs of a travelling street trials rider. B&W is the right address for those looking for high-quality cases and bags that transport equipment reliably and easily. I can highly recommend the cases and bags to any colleague.“

# ACCESSORIES

## **DISTANCE KEEPER**

**(96325)**

Der **DISTANCE KEEPER** ist ein variabler Abstandshalter mit TPE-Polsterung, der die Gabel und den Rahmen des Fahrrads vor Kompression bei Flug- und Autofahrten etc. schützt.

Der **DISTANCE KEEPER** ist Längenverstellbar, daher für alle Fahrradgrößen nutzbar.

The **DISTANCE KEEPER** is a variable spacer with TPE padding to protect fork and frame of the bike from compression while travelling by air, car etc.

The **DISTANCE KEEPER** is adjustable in length and can therefore be used for all bicycle sizes.



## **PROTECTOR SET**

**(96324)**

Schaumstoff- und Abstandshalter für zusätzlichen Schutz  
passend für alle Koffer  
und Taschen

Foam and spacer for additional  
protection

suitable for all cases and bags



## **GEAR BAG SET**

**(96322)**

vier Taschen für Zubehör -  
passend für alle Koffer  
und Taschen

four bags for accessories -  
suitable for all cases and bags

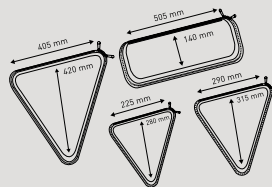



### **WHEEL GUARD M (96802/FARBE)**

**M** - Durchmesser 690 mm | **Laufrad** bis 28"  
**Farbe** schwarz, blau, grün | **Material** Polyester  
**Ausstattung** drei Innentaschen

### **WHEEL GUARD L (96803/COLOR)**

**L** - diameter 29.9 inch | **wheels** up to 29"  
**color** black, blue, green | **material** polyester  
**features** three inward pockets

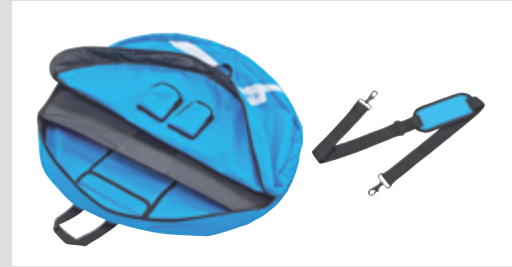

### **DOUBLE WHEEL GUARD M (96812/FARBE)**

**M** - Durchmesser 690 mm | **Laufrad** bis 28"  
**Farbe** schwarz, blau, grün | **Material** Polyester  
**Ausstattung** drei Innentaschen, inkl. Schultergurt

### **DOUBLE WHEEL GUARD L (96813/COLOR)**

**L** - diameter 29.9 inch | **wheels** up to 29"  
**color** black, blue, green | **material** polyester  
**features** three inward pockets, incl. shoulder strap



### **BIKE.SACK (96250/N)**

**Innenmaße** 1.200 x 850 x 230 mm  
**zusammengefalt** 500 x 250 x 90 mm  
**Gewicht** 2,2 kg | **Farbe** schwarz  
**Material** Polyester

**internal dimensions** 47.2 x 33.5 x 9.1 inch  
**folded** 19.7 x 9.8 x 3.5 inch  
**weight** 4.7 lb | **color** black  
**material** Polyester



### **CHAIN GUARD (96350)**

**Außenmaße** 610 x 295 mm | **Gewicht** 0,38 kg  
**Farbe** schwarz | **Material** Polyester

**external dimensions** 24.0 x 11.6 inch  
**weight** 0.8 lb | **color** black | **material** polyester

# HINWEISE ZUM FLUG MIT DEM RAD

## VOR DER REISE

- Erkundigen Sie sich vor der Buchung darüber, ob die Fluggesellschaft Ihr Sportgepäck (Fahrrad im Koffer) mitnimmt und wie hoch die Kosten dafür sind.
- Melden Sie direkt nach Buchung der Reise die Mitnahme des Fahrrades beim Reisebüro / der Fluggesellschaft an.
- Mit der Anmeldung bei der Fluggesellschaft sind Kosten verbunden. Wenn kein anderer Bescheid ergeht, zahlen Sie diese Kosten üblicherweise direkt am Check-in Schalter.
- Denken Sie auch an den Transport vom Flughafen zum Hotel. Bei Pauschalreisen: Melden Sie den Fahrradtransport vom Flughafen zum gebuchten Hotel und zurück bereits bei der Buchung an, da evtl. zusätzliche Kosten entstehen.
- Bei Radsport-Reiseveranstaltern: Hier ist der Transport oftmals im Reisepreis enthalten. Informieren Sie sich rechtzeitig vor Antritt Ihrer Reise.

## DER ABFLUG

- Planen Sie für den Check-in grundsätzlich mehr Zeit ein, wenn Sie mit dem Fahrrad reisen.
- Für Abflüge am frühen Morgen empfehlen wir den Vorabend Check-in, das spart Zeit am Abflugtag.
- Gehen Sie wie üblich an den Check-in Schalter. Nachdem Sie die Bordkarten erhalten haben, geben Sie den Fahrradkoffer üblicherweise am gesonderten Schalter für Sperrgepäck auf.

## AM ZIELFLUGHAFEN

Typischerweise kommt der Fahrradkoffer an einem speziellen Band an oder wird Ihnen als Sperrgepäck übergeben. Selten wird er Ihnen auf dem normalen Kofferband zugestellt.

## BEI BESCHÄDIGUNG DES KOFFERS

Melden Sie Schäden am Fahrradkoffer umgehend der Fluggesellschaft. Auf den meisten Flughäfen hilft man Ihnen am Schalter „Lost & Found“ weiter.

## REISEN IN DIE/INNERHALB DER USA

Alle aufgegebenen Gepäckstücke müssen bei Reisen in die USA durchsucht werden (die Art der Durchleuchtung variiert je nach Flughafen). Der TSA ist leider nicht dafür verantwortlich, den Koffer nach Überprüfung sorgfältig zu verpacken und zu verschließen. Es wird empfohlen, dass Sie sich an den Check-in-Schalter der Fluggesellschaft wenden und einen TSA-Agenten bitten, dass Sie während der Überprüfung dabei sind.

Für Reisetipps und Informationen über TSA-Screeningverfahren und verbotene und erlaubte Gegenstände, besuchen Sie bitte [www.tsa.gov/travel](http://www.tsa.gov/travel).

# AIR TRAVEL WITH YOUR BIKE

## BEFORE TRAVELLING

- Find out before booking whether the airline carries sport luggage (bike in the case) and how much the charges are.
- Notify the travel agency or airline directly during the booking process that you want to take your own bike. This information will be passed on to the airline and you will receive separate notification.
- There are costs associated with registering with the airline. If you don't receive any other notification, these costs are usually paid directly at the check-in desk.
- Also think about transport from the airport to the hotel. For package travel deals: notify the travel agency about bike transport from the airport to the booked hotel and back when booking, otherwise additional costs may arise.
- Cycling event organisers: transport is usually included in the travel cost. Inform yourself in good time before departure.

## DEPARTURE

- You should generally plan more time to check-in when you travel with a bike.
- For early morning departures, we recommend the late night check-in service to save time on the day of departure.
- Report to the check-in desk as usual. Once you have received your boarding pass, you usually have to go to a separate desk for bulky luggage.

## AT THE DESTINATION AIRPORT

The bike case usually arrives on a special conveyor belt or is handed to you through a door for bulky luggage. It is rare for it to arrive on the normal suitcase conveyor belt.

## DAMAGES TO THE CASE

Report any damages to the case immediately to the airline. The "Lost & Found" desk usually helps you at most airports.

## TRAVEL IN THE/WITHIN USA

All checked baggage must be screened—the method of screening varies by airport. Many airports have automated in-line baggage screening systems where your checked baggage is placed on a conveyor belt behind the ticket counter. It is then screened and cleared remotely, outside of public view. This will pose a risk as TSA is not responsible for repackaging and closing the case with the same care that we, or our customers would have. It is recommended that you contact the Airline Check in Counter and request a TSA Agent to stay with the baggage. You may do this ahead of time, or at the time of check in.

For travel tips and information about TSA screening procedures and prohibited and permitted items, please visit [www.tsa.gov/travel](http://www.tsa.gov/travel).

# B3 BAG



## **B3 BAG**

**(96400/GREY + 96400/JEANS + 96400/BLACK)**

**Außenmaße** 300 x 700 x 230 mm

**Volumen** 35 l

**Gewicht** 2,2 kg

**Zuladung** 15 kg

**external dimensions** 47.2 x 33.5 x 9.1 inch

**volume** 35 l

**weight** 4.9 lb

**payload** 33.1 lb





wasserdichte Tasche aus robustem, langlebigem Material

waterproof bag made of tough and durable material



der Teleskopgriff verschwindet in einem Reißverschluss auf der Rückseite der Tasche

the telescopic handle disappears behind the zipper when attached to the bike



zwei stabile Leichtlaufrollen  
two stable and smooth-running wheels



einfache und sichere Montage am Fahrrad Gepäckträger (Ø 6 - 16mm)  
easy and secure mounting on the bike rack (Ø 6-16mm)



**Andrea Gutmann** (Head of the B&W bike.cases Merida Team):

Bei keinem Ausflug oder Urlaub fehlt meine Fahrradtasche B3. Bei Wettkämpfen mit meinem Team, oder bei Fahrradtouren mit meinem Partner ist er ein ebenso unersetzliches Transportmittel für Regenzeug und Verpflegung wie bei kleinen Spaziergängen zu Museen, Burgen oder Stadtbesichtigungen. Die Idee, den B3 mit Rollen auszustatten, ist genial.

My bicycle bag B3 is not missing on any excursion or holiday. For competitions with my team, or for bicycle tours with my partner, it is just as irreplaceable a means of transport for rain gear and food as for short walks to museums, castles or city tours. The idea to equip the B3 with wheels is ingenious.

# FOLDON FAMILY



← FOLDON.BAG PACK → PAGE 28



# FIND YOUR PERFECT CASE



	foldon.bag pack	foldon.box S	foldon.case	foldon.bag
page	28	30	31	31
<b>Außenmaße (mm)</b> external dimensions (inch)	620 x 600 x 350 24.4 x 23.6 x 13.8	675 x 710 x 350 26.6 x 28.0 x 13.8	640 x 700 x 330 25.2 x 27.6 x 13.0	600 x 600 x 200 23.6 x 23.6 x 7.9
<b>Innenmaße (mm)</b> internal dimensions (inch)	610 x 590 x 340 24 x 23.2 x 13.4	635 x 620 x 315 25.0 x 24.4 x 12.4	610 x 625 x 240 24.6 x 24.0 x 9.4	600 x 600 x 200 23.6 x 23.6 x 7.9
<b>Gewicht (inkl. Zubehör)</b> weight (incl. accessories)	4,1 kg 9.1 lb	5,4 kg 11.9 lb	7,2 kg 15.9 lb	1 kg 2.2 lb

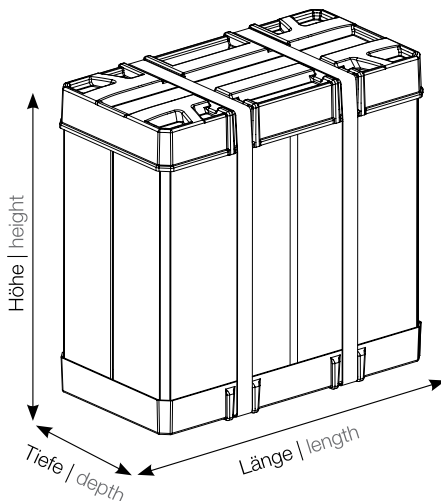

Hinweis: Die Maßangaben verstehen sich Länge x Höhe x Tiefe eines geschlossenen, aufrecht stehenden Koffers bzw. einer geschlossenen, aufrecht stehenden Tasche. Diese Tabelle dient nur einer ersten Orientierung. Für die tatsächliche Nutzungsmöglichkeit vergleichen Sie bitte die Maße Ihres Faltrads im zusammengefalteten Zustand mit den Innenmaßen des jeweiligen Koffers.

**Bitte beachten Sie, dass das foldon.bag pack und das foldon.bag Ihrem Faltrad, im Gegensatz zur foldon.box S und dem foldon.case weniger Schutz bietet.**

Note: The dimensions stated are length x height x depth for a closed upright case or closed upright bag. This table only serves the purpose of providing initial orientation. For the actual possibilities of use, please compare the dimensions of your folding bike folded down with the internal dimensions of the case.

**Please note that the foldon.bag pack and foldon.bag only offers less protection to your folding bike than the foldon.box S and the foldon.case.**

\* Stand: September 2021 | Status: September 2021

# 96004 FOLDON.BAG PACK

**Innenmaße** 610 x 590 x 340 mm  
**Außenmaße** 620 x 600 x 350 mm  
**Gewicht** 4.1 kg  
**Zuladung** 17 kg  
**Farbe** grau/schwarz  
**Material** Ripstop-Polyester

**internal dimensions** 24 x 23.2 x 13.4 inch  
**external dimensions** 24.4 x 23.6 x 13.8 inch  
**weight** 9.1 lb  
**payload** 37.8 lb  
**color** grey/black  
**material** ripstop polyester





Umbau zum Rucksack in nur 2:30 Minuten

conversion to backpack in only 2:30 minutes



zwei stabile Leichtlaufrollen

two stable and smooth-running wheels



Fixierung des Faltrades mit Gurten  
fixation of the folding bike with straps



Schleife zum Anheben und Ziehen  
loop for lifting and pulling



im Lieferumfang enthaltenes Gym Bag für Zubehör

included gym bag for accessories



# 96008 FOLDON BOX S

**Innenmaße** 635 x 620 x 315 mm

**Außenmaße** 675 x 710 x 350 mm

**Zusammengefaltet** 675 x 210 x 350 mm

**Gewicht** 5,4 kg | **Farbe** schwarz | **Material** PP/ABS

**internal dimensions** 25.0 x 24.4 x 12.4 inch

**external dimensions** 26.6 x 28.0 x 13.8 inch

**folded** 26.6 x 8.3 x 13.8 inch

**weight** 11.9 lb | **color** black | **material** PP/ABS



**VIDEO TUTORIAL**

on YouTube:



In weniger als 2 Minuten platzsparend zu verstauen -  
Volumenreduzierung über 70 %

folded in less than 2 minutes -  
volume reduction over 70 %



Vier robuste Rollen, zwei 360° frei drehbar, zwei fest

four durable and smooth-running wheels, two freely rotatable, two fixed



# FOLDON FAMILY



## **FOLDON.CASE (96006/N)**

**Innenmaße** 610 x 625 x 240 mm  
**Außenmaße** 640 x 700 x 330 mm  
**Gewicht** 6,8 kg | **Farbe** schwarz  
**Material** ABS

**internal dimensions** 24.0 x 24.6 x 9.5 inch  
**external dimensions** 25.2 x 27.6 x 13.0 inch  
**weight** 15 lb | **color** black  
**material** ABS



## **FOLDON.BAG (96007/N)**

**Außenmaße** 600 x 600 x 200 mm  
**Gewicht** 1 kg | **Farbe** schwarz  
**Material** Polyester

**external dimensions** 23.6 x 23.6 x 7.9 inch  
**weight** 2.2 lb | **color** black  
**material** polyester



# INLAYS UNLIMITED

Discover the possibilities:  
[www.b-w-international.com](http://www.b-w-international.com)

**B&W** OUTDOOR.CASES

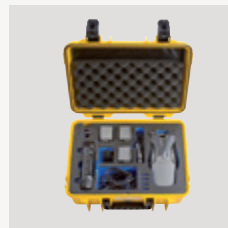
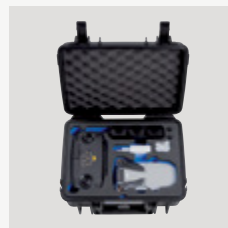
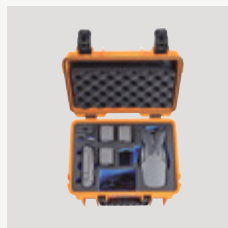
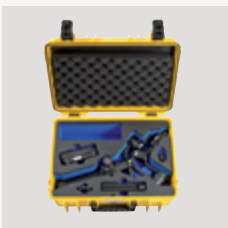
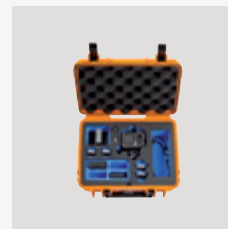
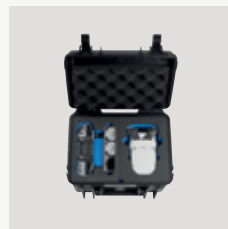
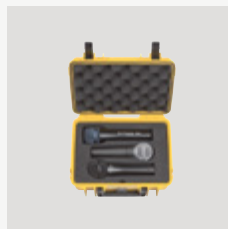
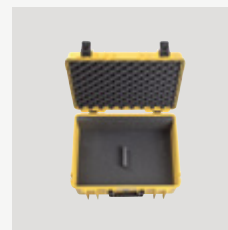
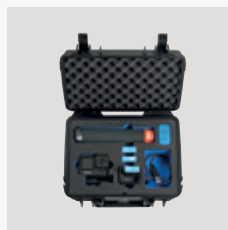
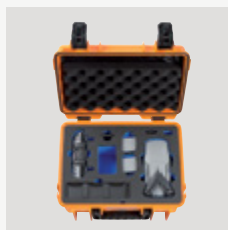





### **JUMBO 6700 (1117.19/P)**

**Innenmaße** 534 x 357 x 225 mm  
**Außenmaße** 609 x 428 x 263 mm  
**Gewicht** 10,8 kg | **Material** PP | **Volumen** 43 l  
**Ausstattung** pockets (P) | **Farbe** schwarz | **Zuladung** 35 kg

**internal dimensions** 21.0 x 14.1 x 8.9 inch  
**external dimensions** 24.0 x 16.9 x 10.4 inch  
**weight** 23.8 lb | **material** PP | **volume** 43 l  
**configuration** pockets (P) | **color** black | **max. load** 77.1 lb

### **SERVICE (116.01)**

**Innenmaße** 440 x 320 x 180 mm  
**Außenmaße** 450 x 340 x 200 mm  
**Gewicht** 2,2 kg | **Material** Polyester | **Volumen** 25 l  
**Farbe** schwarz | **Zuladung** 12 kg

**internal dimensions** 17.3 x 12.6 x 7.1 inch  
**external dimensions** 17.7 x 13.4 x 7.9 inch  
**weight** 4.9 lb | **material** polyester | **volume** 25 l  
**color** black | **max. load** 26.5 lb



### **BASE (120.02/P)**

**Innenmaße** 460 x 355 x 180 mm  
**Außenmaße** 500 x 420 x 200 mm  
**Gewicht** 5 kg | **Material** ABS | **Volumen** 29 l  
**Ausstattung** pockets (P) | **Farbe** schwarz | **Zuladung** 25 kg

**internal dimensions** 18.1 x 14.0 x 7.1 inch  
**external dimensions** 19.7 x 16.9 x 7.9 inch  
**weight** 11 lb | **material** PP | **volume** 29 l  
**configuration** pockets (P) | **color** black | **max. load** 55.1 lb



# TOOL.CASES & BAGS

Discover the possibilities:  
[www.b-w-international.com](http://www.b-w-international.com)



**TOOL.CASES & BAGS**



Das abgebildete Werkzeug ist nicht im Lieferumfang enthalten. | The tools shown are not included in the delivery.

# B&W WORLDWIDE

## 1 DEUTSCHLAND | GERMANY

B&W International GmbH  
Junkendiek 5  
49479 Ibbenbüren  
Germany

fon +49 (0) 5451 89 46 - 0  
fax +49 (0) 5451 89 46 444  
info@b-w-international.com

## 2 SPANIEN | SPAIN

B&W Maletas Industriales S.L.  
Carrer Progrès, 2B  
08850 Gavà (BCN)

fon +34 (0) 93 647 64 84  
fax +34 (0) 93 647 64 83  
spain@b-w-international.com

## 3 NORD AMERIKA | N. AMERICA

B&W North America  
12200 Farmington Rd.  
Livonia, MI 48150 (USA)

fon +1 (0) 734 7 44 55 66  
fax +1 (0) 734 7 44 55 68  
usa@b-w-international.com

## 4 CHINA | CHINA

B&W Jiaxing Co., LTD.  
No. 997 Fenghua Road  
Jiaxing 314036  
ZheJiang, P.R. China

fon +86 (0) 573 8269 3528  
fax +86 (0) 573 8269 3530  
info@b-w-international.com.cn

## 5 INDIEN | INDIA

B&W International India  
F-03/09,  
Near BPTP Villas, Sector 88,  
Faridabad, Haryana 121002,  
India

fon +91 (0) 989 11 140 05  
india@b-w-international.com

## 6 AUSTRALIEN | AUSTRALIA

B&W International Australia  
australia@b-w-international.com



3

1

2

5

4

6



**B&W International GmbH** | **BIKE.CASES & BAGS**

Junkendiek 5 | D-49479 Ibbenbüren

**Fon** + 49 (0) 54 51 / 89 46-0

**Fax** + 49 (0) 54 51 / 89 46-444

info@b-w-international.com

[www.b-w-international.com](http://www.b-w-international.com)

[www.facebook.com/BWbikecasesandbags](https://www.facebook.com/BWbikecasesandbags)

Hinweis: Die auf den Katalogseiten abgebildeten Fahrräder dienen Demonstrationszwecken und sind nicht im Lieferumfang enthalten.

Note: The bikes illustrated on the pages of this catalogue are for demonstration purposes only and are not included in the delivery.